

# *WillowWood*<sup>™</sup>

---

## ALPHA<sup>®</sup>

### Instruction Manual



# CONTENTS

<b>SECTION</b>	<b>PAGE</b>
1 Introduction.....	3
2 Pre-Stretching.....	5
3 Donning.....	6
4 Casting.....	7
5 Cast Modification.....	8
6 Test Socket Evaluation.....	10
7 Definitive Socket Fabrication.....	12
8 Trimming.....	12
9 Cleaning and Care.....	13
10 Troubleshooting.....	16

## 1. INTRODUCTION

**Important Note: For the safety of you and your patients, WillowWood will not resell any returned Alpha Liners that may possibly have been worn.**

### Material Safety Data Sheet

A Material Safety Data Sheet (MSDS) for the Alpha Liner is available from WillowWood upon request.

### Warranty

WillowWood warrants each Alpha Liner from the date of the seller's invoice for a period of 12 months against defects in material and workmanship\*. There is no warranty, expressed or implied, for damage caused by abuse, mishandling or accident. The warranty is void if the fitting and routine care instructions are not followed. For your protection and ours, please thoroughly clean all used products prior to return.

\*Alpha DESIGN Liners will be fabricated based on customer-provided specifications. If a customer is not satisfied with the product, it may be returned within 30 days of invoice for alteration, replacement, or credit at the sole discretion of WillowWood. Credit will only be applied if it is determined the product is not appropriate for the intended patient. Returns will not be accepted for customer errors.

### Warranty Disclaimer

WillowWood warrants that each product manufactured will, at the time of delivery, be of workmanlike quality and substantially free of defects. WillowWood makes no other warranty, implied or expressed, and makes no warranty of merchantability or fitness for a particular purpose. This warranty shall terminate immediately upon an action to combine our products with other materials or in any manner change the nature of our products. The sole remedy is replacement of the products or credit for the products. If a replacement product is provided to a customer, the warranty period will be the number of days remaining on the original warranty. WillowWood's liability shall not exceed the purchase price of the product. WillowWood is not responsible for any indirect, incidental or consequential damage.

### Retention of Rights

WillowWood retains all intellectual property rights reflected in its physical products, regardless of the transfer of the physical products to another party or parties.

### Trial Period

The trial period for an Alpha Liner is 30 days from the date of the seller's invoice. The policy for Alpha Liners returned during the trial period is as follows:

- Credit will be offered for patient rejection, defined as "product not appropriate for patient"
- For all other circumstances, exchange for a different Alpha Liner will be offered

### Returns

A customer's preferred vendor will handle all liner returns\*\*.

If you wish to return a product purchased directly from WillowWood, follow these simple steps:

A. Be prepared to provide the following information:

- Account # or company name
- Purchase order # and/or serial #
- Quantity to be returned
- Reason for return

B. Please call Customer Care at 1.800.848.4930 to get a Return Merchandise Authorization (RMA) number. This must be done before the product is returned.

C. When packing the product, place the RMA number prominently on the outside and inside of the package containing the product being returned.

By following these steps you will guarantee that your return will be processed expeditiously and credited accurately.

\*\*Custom Alpha DESIGN® Liners must be returned to WillowWood directly.

### **Contraindications**

Although the Alpha Liner has been used successfully on thousands of amputees, WillowWood does not recommend using the Alpha on the following types of patients:

- any patient who is either not capable or not willing to comply with the cleaning and disinfecting procedures described in this booklet.
- any patient who lacks the hand strength to roll the liner successfully up onto the residual limb, and who does not have a caregiver to assist with this process.
- any patient who lacks the ability to orient the liner properly on the limb.
- any patient who has a skin condition which could be aggravated by covering the limb with a non-porous liner.
- for the Alpha AK Liner: any patient with a very short residual limb (approximately 3" or shorter) as measured from the perineum to the distal end along the medial side, unless a supplemental method of suspension is used.

## 2. PRE-STRETCHING (FOR CLASSIC AND HYBRID LINERS ONLY)

Each size of Alpha is designed to fit a wide range of limb circumferences. The thermoplastic nature of the Classic and Hybrid liners allows them to be heated and stretched to fit the larger limbs in each size category. This process can be performed prior to the initial donning of the liner to promote a more comfortable fit. Follow either of the two methods listed below.

*Note: Silicone Liners are not heat-moldable.*

### Method 1: Cold Stretching

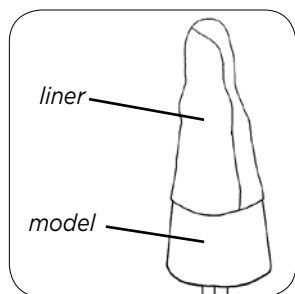

1. Apply a protective barrier to a clean, dry positive model that is similar in size and shape to the residual limb and is longer than the usable length of the Alpha Liner.
2. Roll the Alpha Liner onto the model.
3. Leave the liner on the model for at least one hour. The longer the liner is left on the positive model, the more the liner will take the shape of the model.
4. Remove the liner from the model.

### Method 2: Heat Stretching

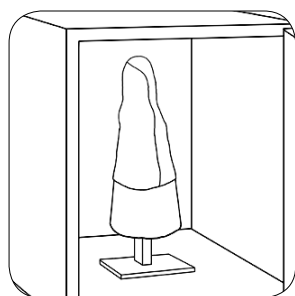

1. Apply a protective barrier to a clean, dry positive model that is similar in size and shape to the residual limb and is longer than the usable length of the Alpha Liner. The positive model can be pre-heated in an oven set at 65°C (150°F) for 10 minutes if desired.

**Note: Be sure to use a positive model that is made of a material that can withstand the heat-stretching temperature.**

2. Roll the Alpha Liner onto the model.
3. Place the positive model, with the liner on it, into a pre-heated oven set at 65°C (150°F).

**Note: DO NOT place the Alpha into the oven unless it is on a positive model, and DO NOT allow the Alpha to come into contact with the heating element or the sides of the oven, or the liner will be damaged and will not be covered under warranty.**

4. Heat the liner in the oven for 2-5 minutes. Allow to cool. If the heat stretching is not sufficient, repeat the process in 5-minute increments, but do not exceed **15 minutes total time** in the oven.
5. Remove the positive model with the liner from the oven. Allow the liner to cool approximately 10 minutes before removing it from the model.

### 3. DONNING

**Do not apply any type of lotion or powder to the residual limb or to the Alpha Liner, as these products could damage the liner. The residual limb should be clean, dry, and free of soap residue. Cover any open wounds or non-intact skin with a bandage or some other appropriate covering to prevent direct contact between the wound and the Alpha Liner.**



Invert the liner so that the gel side is facing out.

Place the end of the liner against the end of the limb.



Carefully roll the liner up onto the residual limb with the gel side against the skin.

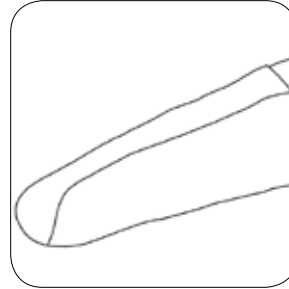

To prevent irritation of the residual limb, make sure that there are no wrinkles or air pockets between the residual limb and the liner.

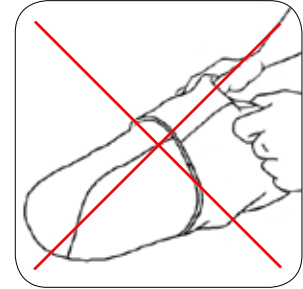

**DO NOT PULL the liner onto the limb. Pulling the liner may stretch the skin and result in discomfort or skin irritation.**

Orient as follows:

BK liner:

logo and serial number to the front

Classic AK liner:

logo to the lateral side

Hybrid AK liner:

no particular orientation is necessary, but varying the orientation can prolong the life of the liner

#### **If using an Alpha Locking Liner:**

- Center the pin attachment on the distal end of the limb.
- Provide a locking pin for each Alpha Locking Liner.
- Use a locking pin with M10-1.5 threads (or 1/4"-20 threads for pediatric liners).
- Apply LocTite Removable Threadlocker 242 (or equivalent) to the pin threads prior to installing the pin.

**Warning: Failure to ensure that the locking pin is secure in the Locking Liner could result in the pin coming out of the liner, resulting in the potential for injury to the amputee.**

Note: WillowWood recommends the use of an additional suspension method such as a suspension sleeve and one of the following lock options:

Alpha Lamination Lock (Part No. 700-AL600)

Alpha Lock (Part No. 700-AIS480)

Alpha Locking Lanyard (Part No. 700-AIS100)

G-Lock (Part No. 700-GL480) or Mini G-Lock (Part No. 700-MGL480)

## 4. CASTING

Fabricating a socket according to these guidelines is the most crucial element in prolonging the life of the Alpha Liner. If you do not follow the Total Surface Bearing concept, the life expectancy of the Alpha Liners will be significantly reduced and you will void the warranty.

The following instructions apply to hand casting and modification. If you use the **OMEGA<sup>®</sup> Tracer<sup>®</sup>** System, refer to the **OMEGA<sup>®</sup> Tracer<sup>®</sup>** User's Guide for directions.

### BK Casting

Don the liner and cover it with a thin plastic or rubber barrier and a thin cast sock. Make any desired reference marks with an indelible pen. Cast over the liner with minimal anatomical distortion.



Make gentle light thumbprints in either side of the patella tendon.

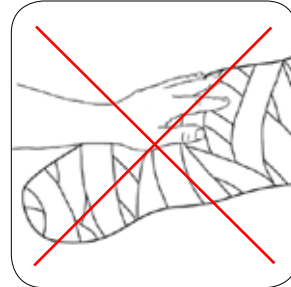

Do not distort or move the soft tissue.

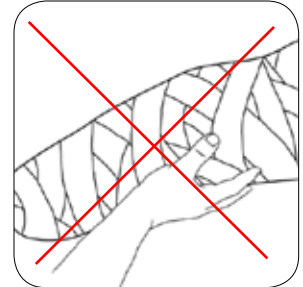

Do not push in on the posterior wall.

### AK Casting

Don the liner. Select the appropriately sized casting brim for the amputee. Try on as many brims as needed to obtain a fit in which the proximal medial border of the brim fits well, all the way up into the perineum, and contains the ischium. Make a note of any loose areas so that they can be addressed in the cast modification.

**Note: The brim should fit properly without having to pull the residual limb through the brim from the distal end.**

Cover the liner with a thin plastic or rubber barrier.

Install the selected casting brim onto a weight-bearing casting fixture. Have the amputee insert the limb into the casting brim. Fold the proximal edge of the liner back over the proximal edge of the brim.

Make any desired reference marks with an indelible pencil.

Cast over the liner using moderate tension. **As the cast dries, apply upward pressure to the distal end to simulate some distal end weight bearing (as tolerated by the amputee), and apply inward pressure along the lateral wall proximal to the distal end of the femur. Do not allow the residual limb to bend below the brim in either the A/P or the M/L plane.**

After the cast has hardened, slide the cast and the brim off of the amputee. Have the amputee hold onto the proximal edge of the Alpha AK Liner so that the liner stays in place while the cast is being removed.

**NOTE: If the cast has a curved shape (due to the amputee's leg not being completely vertical during casting), discard the cast and start over.**

## 5. CAST MODIFICATION

The goal of the modification is to achieve Total Surface Weight Bearing of the residual limb for optimum performance of the Alpha Liner. To achieve this, the modifications involve reduction of the positive model only. **DO NOT build up the model in ANY area.** This includes areas which you may have typically built up in the past, such as the anterior distal tibia and the head of the fibula on a BK, or the distal end on an AK.

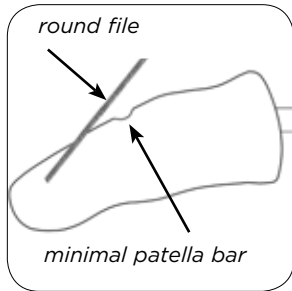

For BK models: if desired, carve a patella bar that is straight and no deeper than 1.5cm (5/8").

For AK models: smooth out any ridges, bulges, or prominent flares formed by the brim. Reduce any areas where the fit between the brim and the liner was loose. Establish a flat, straight wall down the medial side.

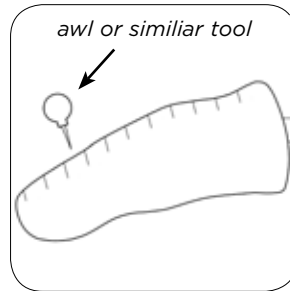

Make a series of reference marks along the model, approximately 1" (25 cm) apart for BK models, and 2" (50 cm) apart for AK models.

To maintain the reference marks when plaster is removed, pierce the model at each of the marks.

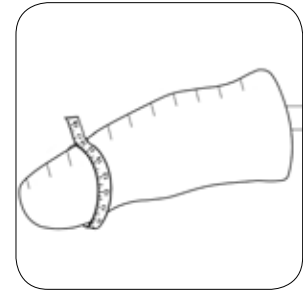

Measure and record the circumference at each of the marks. Reduce each circumference by the amount listed below to obtain the goal circumferences.

Reduce each circumference by the amount listed below to obtain the goal circumferences.

Uniform, Tapered, Contoured			Progressive	AK
3 mm	6 mm	9 mm		
3-5%	5-7%	7-9%	5-7%	3-6%



The suggested reduction amounts may vary depending on casting technique, limb length, and tissue type.

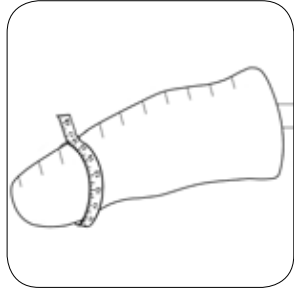
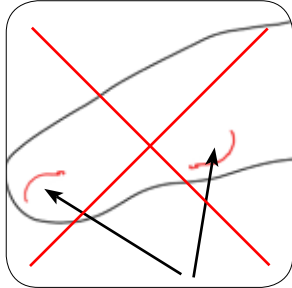
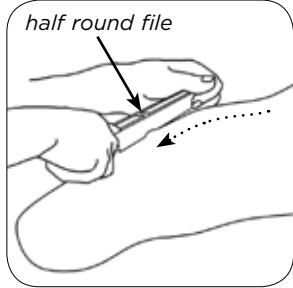

Remove the plaster symmetrically by pulling the file from the proximal edge of the model toward the distal end in one continuous motion. Repeat 3 or 4 times at each spot. Remove an even layer of plaster everywhere, following all contours without changing them. Do NOT reduce the length.

Do not add plaster - not even at the fibula head or at the distal tibia.

After reducing the whole surface, re-measure at each awl hole. Repeat until you have achieved the goal circumferences. Use sandscreen to smooth out the file marks on the positive model.

**Note:**

**A half-round file is recommended because it helps to maintain the contour of the positive model. Do not simply reduce the prominent points of the positive model while leaving the rest alone.**

**On very conical, bony limbs, it may be necessary to use a Scarpas knife to remove plaster around the base of the bony prominence that the half-round file will miss.**

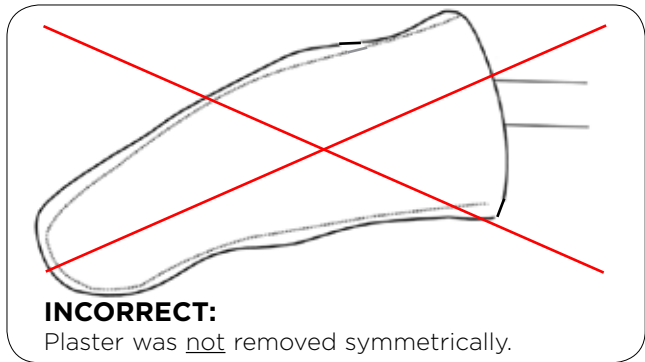

## 6. TEST SOCKET EVALUATION

**Regardless of the method used to capture and modify the shape of the limb, it is necessary to fabricate a clear test socket and to evaluate the fit using the following techniques:**

Fabricate a clear test socket from the modified positive model. Since there are no major undercuts or build-ups on the model, it should be possible to blow the test socket off the model with air pressure. This allows the model to be preserved in case additional modifications are required based on the test socket fitting.

Drill a small hole in the distal aspect of the test socket to allow air to escape during donning. Place the hole as distal as possible without preventing the prosthetist from having access to the hole when the amputee stands on a fitting stool. If using a Locking Liner, the hole should be just large enough to allow the threaded insert at the end of the umbrella to fit through the hole, in order to allow the umbrella to conform to the distal end of the socket.

Have the amputee don the Alpha Liner and socket and stand on a fitting stool. If a Locking Liner umbrella drags on the edge of the socket, apply a small amount of talcum powder or water to the umbrella area only.

Cover the hole in the test socket with transparent pressure-sensitive tape. This should result in a suction fit, regardless of whether the Alpha is a Cushion Liner or Locking Liner.

Evaluate the fit of the test socket as follows:



For AK sockets only: Attach Velcro®-type material to the anterior and lateral sides of the socket, 1 1/2" (4 cm) below the trim line.

*Note: Velcro®-type material does not stick to the one-way stretch fabric of the AK Hybrid Liner.*

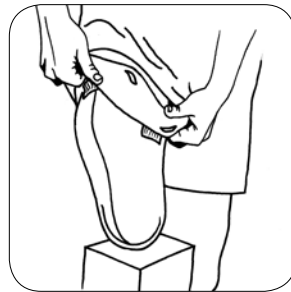

For AK sockets only: Fold the edge of the liner over the top of the socket, smooth out any bunches or folds in the liner, and attach to the Velcro-type material. Do not pull the proximal edge of the liner down so tightly that the liner prevents the limb from reaching the distal end of the socket.

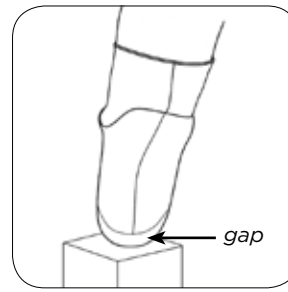

The socket is **TOO TIGHT** (or the socket is too long) if the limb does not contact the distal end of the socket in full weight bearing.

Ask the amputee to put as much weight as possible on the amputated side and to report any discomfort.

Ask the amputee to lift the residual limb off of the fitting stool. The socket should remain in place on the limb without developing any voids at the distal end.

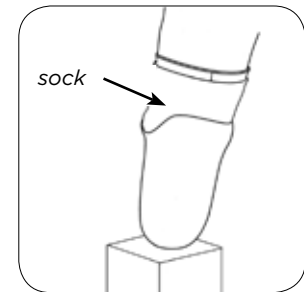

The socket is **TOO LOOSE** if the amputee can don a sock over the liner and slide down easily to the distal end of the socket.

The socket **FITS CORRECTLY** if:

- 1) the limb begins to make slight distal contact under full weight bearing
- 2) the limb contacts the distal end of the socket without socks on the liner
- 3) adding one single-ply sock over the liner prevents the limb from contacting the distal end of the socket under full weight bearing.

**Additional Fitting Tips**

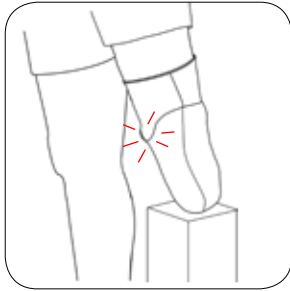

For BK sockets: check to see if the socket is tight around the edges of the patella when the leg is at full extension. If so, ease out the edges to prevent premature wear of the fabric.

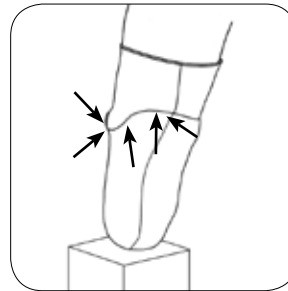

For BK sockets: ease out the edges of the socket everywhere so that the brim does not “saw” into the liner with the normal movements of the leg.

Examine the weave of the Alpha fabric and the spacing of the Alpha stitches. Shining a bright light onto the clear test socket may help you to see the weave and the stitches clearly. Uneven spacing of the stitching or the weave indicates that there are uneven pressures in the socket.

**CORRECT:**

*Stitches are evenly spaced.*

**CORRECT:**

*The fabric weave is evenly spaced.*

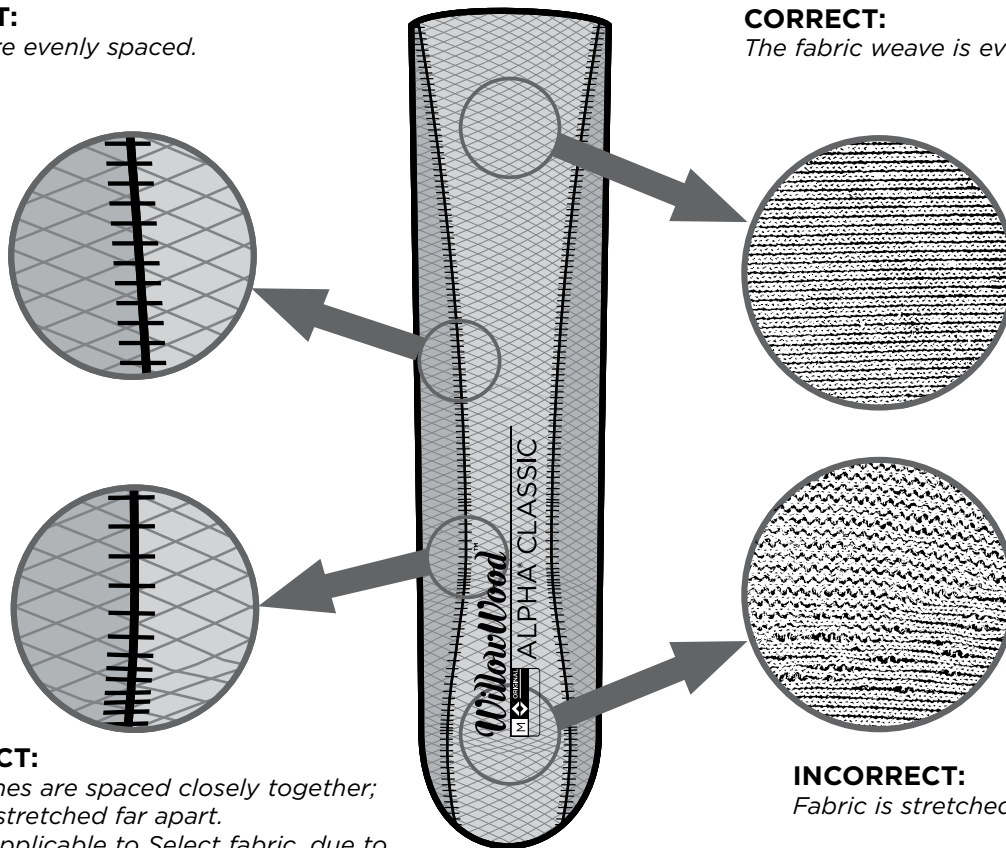

**INCORRECT:**

*Some stitches are spaced closely together; others are stretched far apart.  
Note: not applicable to Select fabric, due to the limited longitudinal stretch of the fabric.*

**INCORRECT:**

*Fabric is stretched out.*

Modify the test socket to correct any areas of discomfort or improper fit. Be sure to maintain Total Surface Weight Bearing.

Once the desired test socket fit has been achieved, conduct the dynamic alignment and fitting.

## 7. DEFINITIVE SOCKET FABRICATION

The final socket should have smooth, flowing contours and no sharp edges. If you are using a carbon fiber socket, cover the brim with leather or a similar padding to prevent the thin, sharp brim from tearing the Alpha fabric over time.

Pay close attention to the posterior trim line. It should not dig into the Alpha fabric when the amputee flexes the knee.

The inside of the socket must be perfectly smooth with no sharp edges. If a hole is drilled in the distal end of the socket, make sure that the edges have no sharp burrs that can snag the fabric, and create a flush surface by installing a Poron Filter (included with WillowWood's Suction Pyramid and LimbLogic® VS 4-Hole Adapter, and also available separately as item number 700-AIS487).

## 8. TRIMMING

If desired, trim the Alpha Liner to a shorter length (for a BK, no shorter than 3" or 8 cm above the medial/lateral brim of the socket; for an AK, not within 1" or 3 cm of where the Velcro®-type material attaches. Use sharp scissors, a paper cutter, or a Hand-Held Cutting Wheel (WillowWood Part No. 700-TL002).

If using the Hand-Held Cutting Wheel, place the liner on a cutting board or thick piece of plastic. Using a straight edge as a guide, roll the cutting wheel cross the liner.

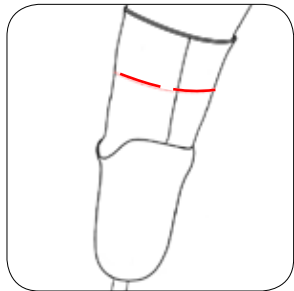

Trim straight across.

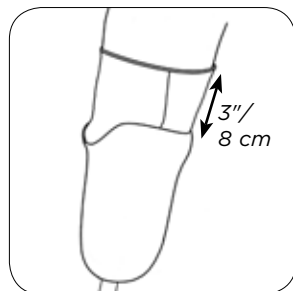

GOOD

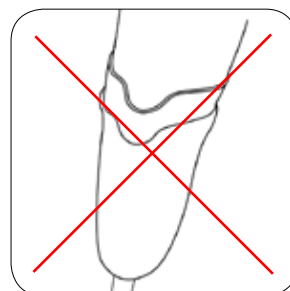

DO NOT FOLLOW THE CONTOUR.



TOO SHORT.

### To help prevent the seam from unraveling:

Place a small drop of instant adhesive\* on the seam directly below the trimmed edge.

### Repairing an unraveling seam:

Place a small drop of instant adhesive\* on the seam directly below where the liner has begun to unravel.

*\*Before the instant adhesive completely soaks into the seam, apply a drop of accelerant directly on top of the adhesive.*

**Note: if you do not apply any accelerant to the instant adhesive, be sure to wait until the instant adhesive sets up before using the liner.**

## 9. CLEANING AND CARE

**Proper hygiene is extremely important when using the Alpha Liner. Please review these care instructions very thoroughly with the amputee.**

The liner must be thoroughly cleaned at the end of each day of wear. WillowWood strongly recommends providing each amputee with two Alpha Liners so that the amputee can wear one while cleaning and drying the other. Rotating the liners also allows fresh mineral oil to flow to the surface of Classic and Hybrid liners between uses.

### Assembling the Drying Stand

Assemble the Drying Stand from the the two base components and the tube that are included in the box. Slide the notch on Part A into the notch on Part B as shown. Then place the tube onto the assembled base.

If you wish to have a shorter Drying Stand to accommodate shorter liners, simply trim the tube to the desired length before placing the tube on the base.

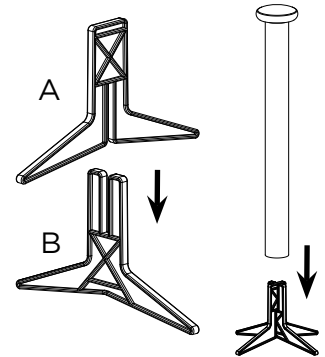

### Daily Cleaning



With the gel side of the liner facing out, clean the liner thoroughly with lukewarm tap water and a body soap that does not irritate the skin. Apply the soap either with a clean, soft cloth or sponge.

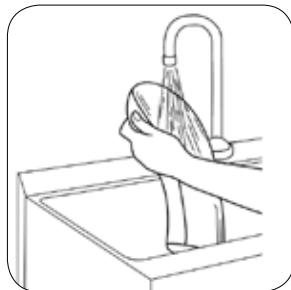

Rinse **all** the soap residue from the liner with water.



Dry the gel side of the liner with a clean, lint-free cloth.

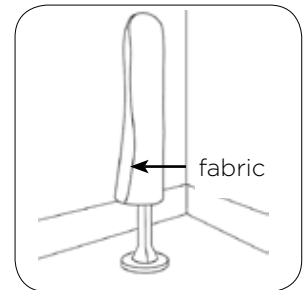

Invert the liner so that the fabric is on the outside and the gel is on the inside.

Place the liner, **fabric side out**, onto the Drying Stand.

Clean the residual limb with soap and rinse well.

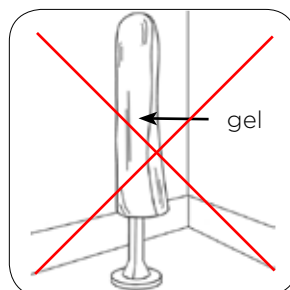

**Caution: Drying the liner with the gel side out will damage the liner.**

## Weekly Disinfection



Place a small amount of ethyl or isopropyl alcohol on a soft, clean cloth.

Lightly wipe the gel side of the liner with the cloth for two minutes. Rinse off any excess alcohol with water.



Rinse off any excess alcohol with water.

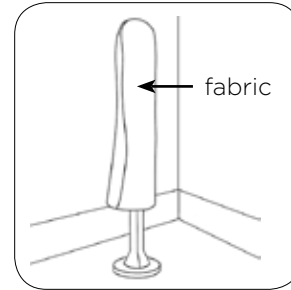

Place the liner, fabric side out, on the drying stand and allow it to dry.

**Note: Do not immerse the liner in ethyl or isopropyl alcohol. Extended contact with large amounts of ethyl or isopropyl alcohol will stiffen the liner.**

## Daily Inspection of the Liner

Explain to the amputee that every Alpha Liner should be inspected after each day of use. The amputee should examine the liner very carefully for any signs of damage or unusual wear, which may indicate changes in the prosthetic fit. In order to preserve the warranty, be sure to instruct the amputee to contact you immediately if any unusual wear is noticed.

If using a Locking Liner, check to ensure that the locking pin is secure. Instruct the amputee to contact you immediately if any looseness is noticed.

### **Perspiration**

Any amputee that engages in an activity that could result in excessive perspiration should be instructed to periodically remove the liner and dry off the liner and residual limb to prevent slippage of the liner on the limb.

### **Repairing Worn Seams**

Instant adhesive is required for use in repairing seams that have worn due to a rough socket edge or movement in the socket. Refer to the appropriate procedure below, based on the condition of the liner. **Note: To prevent further damage to the liner, be sure to repair the socket condition which caused the worn seam (tighten a loose socket fit, apply padding to a rough socket fit, apply padding to a rough socket edge, etc.).**

**1. If the thread is gone, but the fabric and gel are intact:**

- a. Trim off any long threads or loose, abraded fabric to prevent sharp edges from forming.
- b. Pull the fabric back together into its original position. Sew the edges of the fabric together if desired.
- c. Apply the instant adhesive to the entire worn area, extending 3mm (1/8") past the worn area.

**2. If the fabric is eroded, but the gel is intact:**

- a. Apply a cloth patch slightly larger than the worn area.
- b. Apply the instant adhesive as described above.

**3. If the gel has eroded through, repairs will not be effective.**

### **Storage**

When the liner is not being worn, it should be stored fabric side out in a cool, dry place. If the liner will not be used for an extended period, cover the dry liner with a clean plastic bag.

## 10. TROUBLESHOOTING



<b>Problem</b>	<b>Probable Cause</b>	<b>Solution</b>
Fabric or gel breaking down in the anterior distal tibia area.	The socket is loose in that area, possibly due to a build-up in the socket or residual limb shrinkage.	Insert a pad in the socket in that area to tighten the socket up.
Fabric wearing out along socket trim line.	Liner is rubbing against the trim line of the socket.	Smooth out the shape of the trim line. Make sure that the liner does not rub across the socket during flexion/extension. Add padding such as leather to the brim if necessary.
Locking Liner is pistoning up and down in the socket.	Residual limb may have shrunk.	Tighten socket fit.
Residual limb and liner rotate inside the socket.	Residual limb is extremely cylindrical, and socket is loose.	Tighten socket fit.
Gel is pulling away from fabric along proximal edge of liner.	Liner is cut too short, causing the proximal edge of the liner to rub across the socket.	Change to a longer liner.
Top edge of liner is rolling down the leg.	Liner is too short.	Change to a longer liner.
	Liner is too tight at the proximal end.	Confirm that the amputee is wearing the correct size of liner. If it is a Classic or Hybrid liner, heat and stretch the liner if necessary (page 5).
Seam is wearing or unraveling.	Movement or rough socket edge.	Apply instant adhesive to the seam.
Open wounds and non-intact skin.	Could be caused by a number of issues, including socket fit and specific patient variables.	Address the specific cause of the situation, and apply a bandage or other appropriate covering to prevent direct contact between the wound and the Alpha Liner.
Amputee who has been wearing an Alpha Liner for a long time without sweating has suddenly started sweating again.	Air is getting between the liner and the residual limb, possibly due to residual limb shrinkage.	Check the fit of the liner and socket. Tighten up the socket or change to a liner of a different size, style, or thickness.
	Liner has a hole in it.	Replace the liner.



<b>Problem</b>	<b>Probable Cause</b>	<b>Solution</b>
Amputee who is a new Alpha Liner user is perspiring excessively	Body has not yet adjusted to the closed environment of the liner.	<p>The perspiration should subside after several weeks of Alpha Liner use.</p> <p>Any patient that engages in an activity that could result in excessive perspiration should be instructed to periodically remove the liner and dry off the liner and residual limb to prevent slippage of the liner on the limb.</p> <p>Some amputees have found the moderat application of unscented alum-based anti-perspirant to the residual limb prior to donning the liner to be an effective method of controlling excessive perspiration. Always follow label directions, and never use anti-perspirant if there are open sores on the residual limb. Note: non-alum-based products may damage the gel.</p>
Skin irritation all over the residual limb.	Poor hygiene.	Review proper cleaning, rinsing, and disinfecting procedures with the amputee.
	Use of an irritating lotion, cream, powder, or soap.	Check to see whether the amputee has recently changed to a different cleaning product, or has started using any lotions, creams, or powders containing hydrocarbon oils or animal fats or oils. (For some amputees, antibacterial soap has caused skin irritations.)
	The liner or the socket is loose, possibly due to residual limb shrinkage.	Tighten up the socket or change to a liner of a different size, style, or thickness to eliminate the looseness. To confirm that this is not an allergic reaction, perform a "patch test": apply a piece of Alpha material somewhere else on the body and look for a reaction.
Skin irritation along the proximal edge of the liner.	Amputee is pulling the liner up onto the skin instead of rolling it.	Refer to proper donning instructions on page 6. Cutting the proximal edge in a wave pattern may also reduce the irritation.

# *WillowWood*<sup>™</sup>

The Ohio Willow Wood Company   
15441 Scioto Darby Road  
Mt. Sterling, OH 43143  
phone 740.869.3377 / 800.848.4930  
fax 740.869.4374 [www.willowwoodco.com](http://www.willowwoodco.com)

Ohio Willow Wood Company B.V.   
Keizersgracht 62/64  
1015 CS Amsterdam   
The Netherlands